

THIS DOCUMENT IS THE PROPERTY OF
KEYSTONE ELECTRONICS CORP. AND
SHALL NOT BE REPRODUCED, DISTRIBUTED
OR USED AS A BASIS FOR MANUFACTURE
WITHOUT PRIOR WRITTEN PERMISSION
FROM KEYSTONE ELECTRONICS CORP.

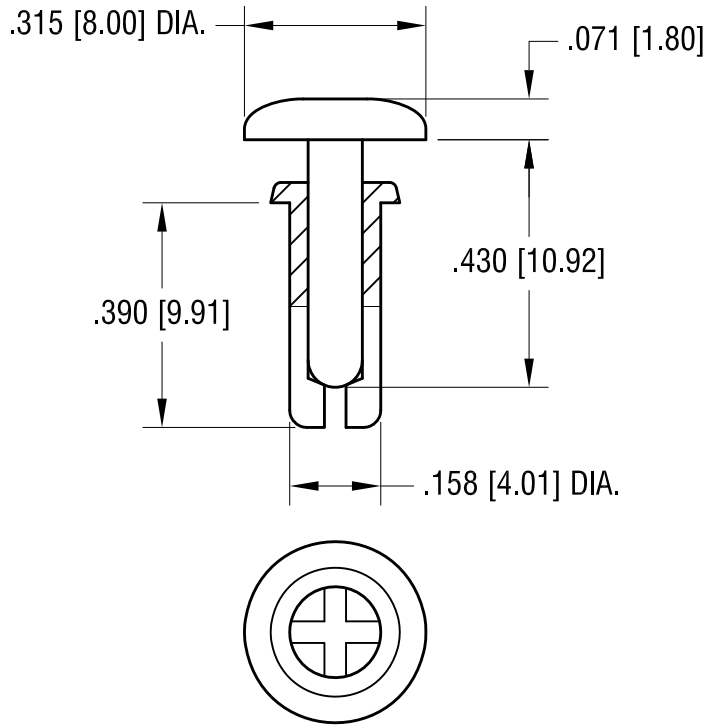

NOTES:

1. RECOMMENDED MOUNTING HOLE:
.163 [4.14] DIA.
2. MAXIMUM MATERIAL THICKNESS:
.335 [8.51]

KEYSTONE ELECTRONICS CORP.			
ASTORIA, N.Y. 11105-2017			
PART NAME		SNAP RIVET	
MATERIAL		NYLON UL 94V-2	
FINISH	DRN BY	DATE	
-	BOONE	9.29.06	
	APP'D	SCALE	
	LN	3X	
TOLERANCES	INCH	[MM]	CODE
DECIMAL	± .010	[± 0.25]	C/M
ANGULAR	± 1°		
UNLESS OTHERWISE SPECIFIED			DWG NO.
			3450

DATE	DESCRIPTION	REV.