

PC SCREW TERMINALS

These easy-to-mount, multipurpose screw type terminals are a practical, low-cost alternative to PC screw type edge connectors, barrier blocks, terminal boards and terminal strips. Steadfast and easy to install, will accommodate solid or stranded wire, crimp type terminals or lugs. Multi-placement of these low-profile terminals make them ideally suited for high density packaging. Supplied unassembled or with screw installed and captivated.

PRINCIPAL FEATURES

- Low profile
- Stable, no-rock design with exclusive anti-rotational feature
- Easily mounts with four legs into pre-drilled or punched holes
- Accepts #14-22 AWG solid or stranded wire, crimp type terminals or lugs
- Ideally suited for high-density packaging
- Available in horizontal or vertical mounting
- Space-saving and time saving
- Easy accessibility for PC board testing
- Binding screw is positioned above board level to avoid wicking during wave soldering
- Terminals are made of Brass with Tin Plate
- Supplied with a combination drive 6-32 binding head screw

CAT. NO. COLOR SUFFIX
Ex: XXXX -X

COLOR SELECTION:

Select desired screw terminal and add color suffix to the screw terminal Cat. No.

HEAD COLOR	SUFFIX
RED	-2
BLACK	-3
WHITE	-4
BLUE	-5
GREEN	-6
YELLOW	-7
NICKEL	none

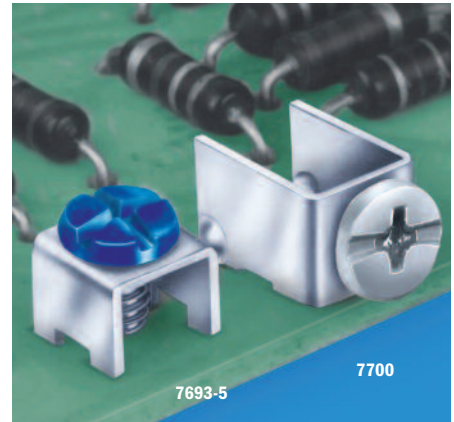

7692-2

SNAP-IN PC MOUNT

- Color coded screws available (add color screw suffix to Cat. No.)

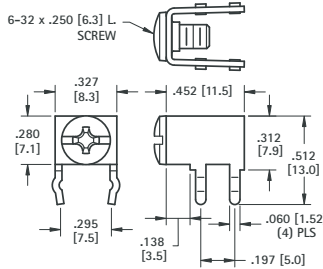

HORIZONTAL TYPE

SPECIFICATIONS

Rated: 15 Amps
Terminal: .032 (.81) Brass, Matte Tin Plate
Binding Head Screw: Brass, Nickel Plate

Mounting Detail

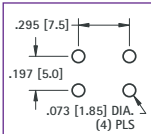

Color coded screws available (add color screw suffix to Cat. No.)

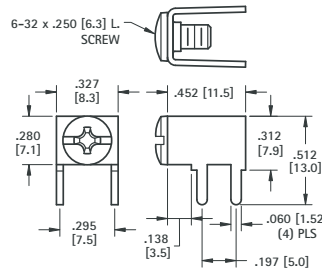

7700-3

PC MOUNT

- Color coded screws available (add color screw suffix to Cat. No.)

CAT. NO. 7779 (No Screw Supplied)

CAT. NO. 7690 (Screw Supplied Unassembled)

CAT. NO. 7692 (Screw Installed & Captivated)

CAT. NO. 7781 (No Screw Supplied)

CAT. NO. 8190 (Screw Supplied Unassembled)

CAT. NO. 7700 (Screw Installed & Captivated)



7773

SNAP-IN PC MOUNT

- Color coded screws available (add color screw suffix to Cat. No.)

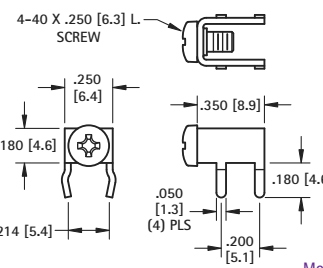

Mounting Detail

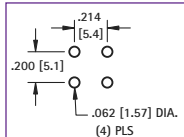

SPECIFICATIONS

Rated: 15 Amps
Terminal: .032 (.81) Brass, Matte Tin Plate
Binding Head Screw: Brass, Nickel Plate

45°

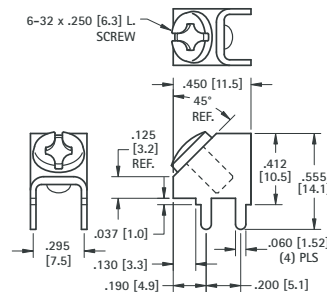

7702-7

PC MOUNT

- Color coded screws available (add color screw suffix to Cat. No.)

Mounting Detail

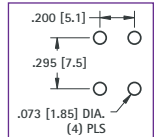

CAT. NO. 7774 (No Screw Supplied)

CAT. NO. 7773 (Screw Supplied Unassembled)

CAT. NO. 7783 (No Screw Supplied)

CAT. NO. 8189 (Screw Supplied Unassembled)

CAT. NO. 7702 (Screw Installed & Captivated)



7693-4

SNAP-IN PC MOUNT

- Color coded screws available (add color screw suffix to Cat. No.)

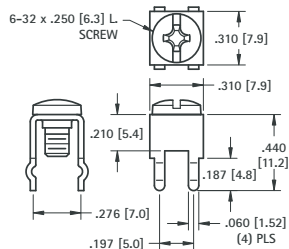

Mounting Detail

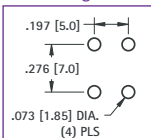

Color coded screws available (add color screw suffix to Cat. No.)

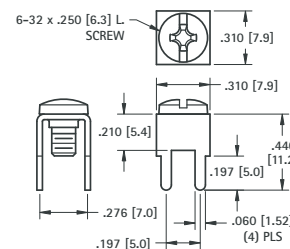

7701

PC MOUNT

- Color coded screws available (add color screw suffix to Cat. No.)

CAT. NO. 7780 (No Screw Supplied)

CAT. NO. 7691 (Screw Supplied Unassembled)

CAT. NO. 7693 (Screw Installed & Captivated)

CAT. NO. 7782 (No Screw Supplied)

CAT. NO. 8191 (Screw Supplied Unassembled)

CAT. NO. 7701 (Screw Installed & Captivated)

PC SCREW TERMINALS

LOW PROFILE VERTICAL TYPE

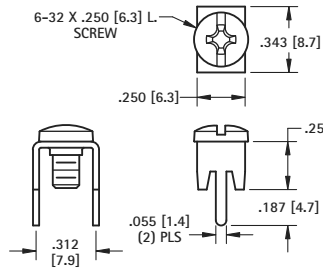

SPECIFICATIONS

Rated: 15 Amps
Terminal: .032 (.81) Brass, Matte Tin Plate
Binding Head Screw: Brass, Nickel Plate

Mounting Detail

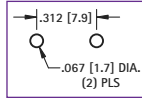

CAT. NO. 7784 (No Screw Supplied)

CAT. NO. 8198 (Screw Supplied Unassembled)

CAT. NO. 7778 (Screw Installed & Captivated)

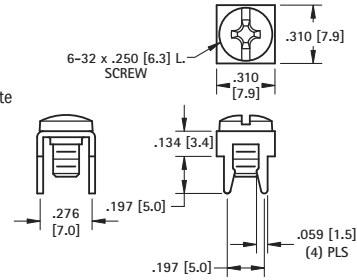

CAT. NO. 7785 (No Screw Supplied)

CAT. NO. 8195 (Screw Supplied Unassembled)

CAT. NO. 7775 (Screw Installed & Captivated)

• Color coded screws available (add color screw suffix to Cat. No.)

Mounting Detail

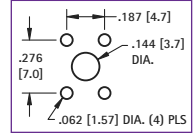

VERTICAL TYPE



EXTENDED

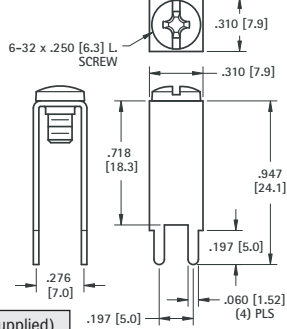

SPECIFICATIONS

Rated: 15 Amps
Terminal: .032 (.81) Brass, Matte Tin Plate
Binding Head Screw: Brass, Nickel Plate

Mounting Detail

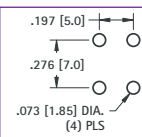

CAT. NO. 7789 (No Screw Supplied)

CAT. NO. 7697 (Screw Supplied Unassembled)

CAT. NO. 7699 (Screw Installed & Captivated)

HEAVY DUTY

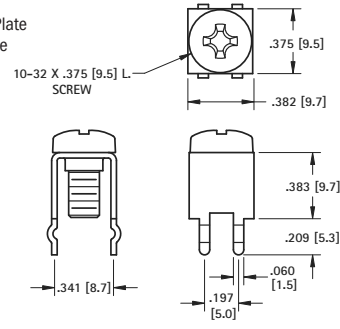

CAT. NO. 7791 (No Screw Supplied)

CAT. NO. 8174 (Screw Supplied Unassembled)



Mounting Detail

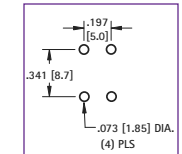

30 AMP - HEAVY DUTY



HORIZONTAL

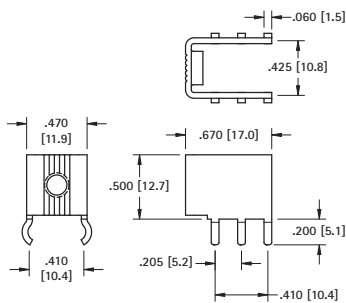

SPECIFICATIONS

Rated: 30 Amps
Terminal: .045 (1.14) Brass, Matte Tin Plate
Screw: Stainless Steel

Mounting Detail

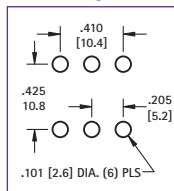

CAT. NO. 7801 (No Screw Supplied)

CAT. NO. 8166 (Screw Supplied Unassembled)

VERTICAL

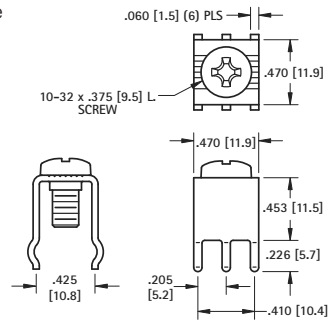

CAT. NO. 7787 (No Screw Supplied)

CAT. NO. 8196 (Screw Supplied Unassembled)



30 AMP

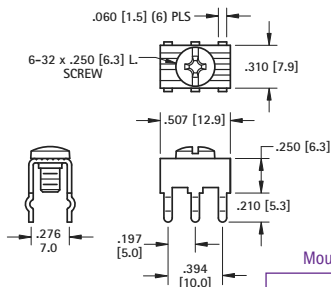

Mounting Detail

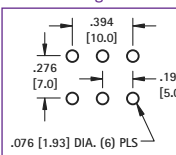

SPECIFICATIONS

Rated: 30 Amps
Terminal: .032 (.81) Brass, Matte Tin Plate
Binding Head Screw: Brass, Nickel Plate

CAT. NO. 7786 (No Screw Supplied)

CAT. NO. 8197 (Screw Supplied Unassembled)

CAT. NO. 8199 (Screw Installed & Captivated)

COLOR CODED GUIDE

CAT. NO. COLOR SUFFIX
 Ex: XXXX -X

COLOR SELECTION:
 Select desired screw terminal and add color suffix to the screw terminal Cat. No.

HEAD COLOR	SUFFIX
RED	-2
BLACK	-3
WHITE	-4
BLUE	-5
GREEN	-6
YELLOW	-7
NICKEL	none

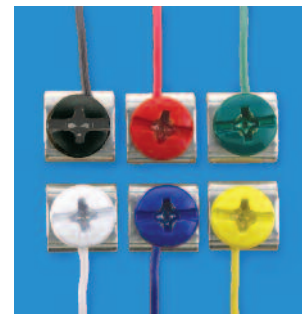

Refer to page 69 for color screws only

SEMS SCREW TERMINALS

SPECIFICATIONS

Terminal: .032 (.81) Brass, Matte Tin Plate
Screw & Washer: Steel, Nickel Plate

SEMS Screw Terminals provide quick and secure attachment of wire leads. SEMS screw has captivated, free spining lock washer, eliminated twisting of wire when tightening lead to terminal. Washer will rise with head of screw when unscrewed.

15 AMP

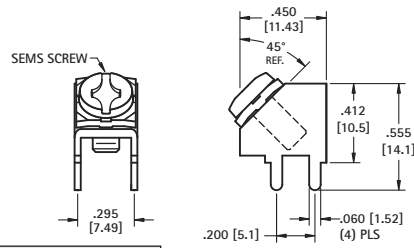

CAT. NO. 8189-SEMS (Screw Supplied Unassembled)
CAT. NO. 7702-SEMS (Screw Installed & Captivated)

SEMS SCREW ONLY

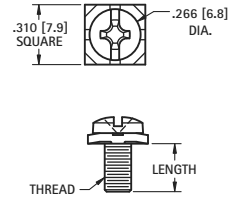

CAT. NO.	THREAD	LENGTH
9920	6-32	.250 (6.4)
9923	M3	.188 (4.8)

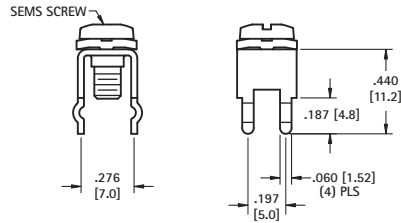

6-32 THREAD		M3 THREAD	
CAT. NO.		CAT. NO.	
7681-SEMS	Screw Supplied Unassembled	7698-SEMS	
7693-SEMS	No Screw Supplied	7696-SEMS	

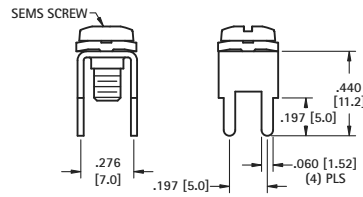

6-32 THREAD		M3 THREAD	
CAT. NO.		CAT. NO.	
8191-SEMS	Screw Supplied Unassembled	7771-SEMS	
7701-SEMS	No Screw Supplied	7772-SEMS	

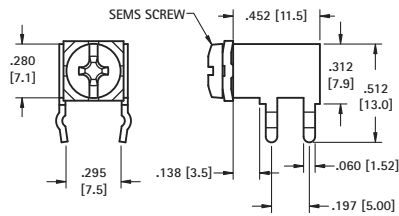

6-32 THREAD		M3 THREAD	
CAT. NO.		CAT. NO.	
7690-SEMS	Screw Supplied Unassembled	7699-SEMS	
7692-SEMS	Screw Installed & Captivated	7695-SEMS	

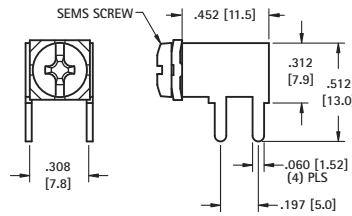

6-32 THREAD		M3 THREAD	
CAT. NO.		CAT. NO.	
8190-SEMS	Screw Supplied Unassembled	7761-SEMS	
7700-SEMS	No Screw Supplied	7762-SEMS	

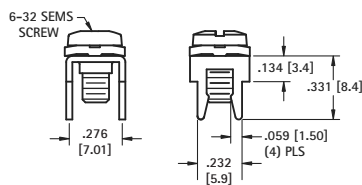

CAT. NO. 8195-SEMS (Screw Supplied Unassembled)
CAT. NO. 7775-SEMS (Screw Installed & Captivated)

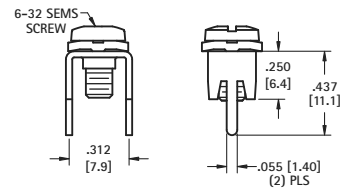

CAT. NO. 8198-SEMS (Screw Supplied Unassembled)
CAT. NO. 7778-SEMS (Screw Installed & Captivated)

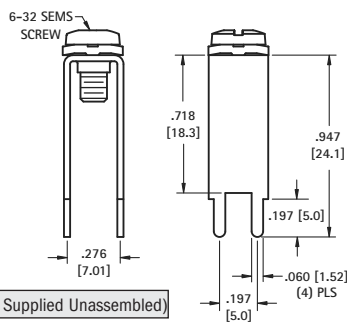

CAT. NO. 7697-SEMS (Screw Supplied Unassembled)
CAT. NO. 7699-SEMS (Screw Installed & Captivated)

30 AMP

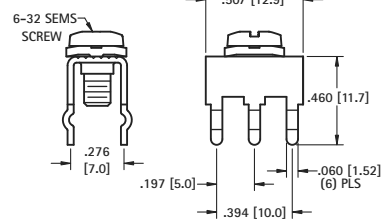

CAT. NO. 8197-SEMS (Screw Supplied Unassembled)
CAT. NO. 8199-SEMS (Screw Installed & Captivated)



SEMS SCREW TERMINALS

METRIC PC SCREW TERMINALS

These easy-to-mount, multipurpose screw type terminals are a practical, low-cost alternative to PC screw type edge connectors, barrier blocks, terminal boards and terminal strips. Steadfast and easy to install, will accommo-

date solid or stranded wire, crimp type terminals or lugs. Multi- placement of these low-profile terminals make them ideally suited for high density packaging. Supplied unassembled or with screw installed and captivated.

PRINCIPAL FEATURES

- Stable, no-rock design with exclusive anti-rotational feature
- Easily mounts with four legs into pre-drilled or punched holes
- Accepts #14-22 AWG solid or stranded wire, crimp type terminals or lugs
- Ideally suited for high-density packaging
- Easy accessibility for PC board testing
- Binding screw is positioned above board level to avoid wicking during wave soldering
- All dimensions appear in millimeters

HEAD COLOR	SUFFIX
RED	-2
BLACK	-3
WHITE	-4
BLUE	-5
GREEN	-6
YELLOW	-7
NICKEL	none

COLOR SELECTION:
Select desired screw terminal and add color suffix to the screw terminal Cat. No.

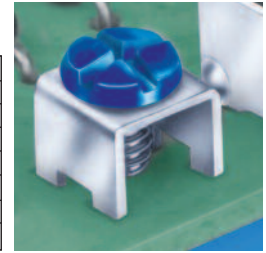

Refer to page 69 for color screws only

HORIZONTAL TYPE



SNAP-IN PC MOUNT

- Color coded screws available (add color screw suffix to Cat. No.)

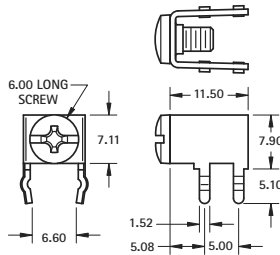

SPECIFICATIONS

Rated: 15 Amps
Terminal: .81 Brass, Matte Tin Plate
Screw: Brass, Nickel Plate

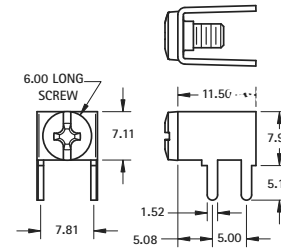

PC MOUNT

- Color coded screws available (add color screw suffix to Cat. No.)

M3 THREAD CAT. NO.	No Screw Supplied	M4 THREAD CAT. NO.
7790	No Screw Supplied	7792
7689	Screw Supplied Unassembled	7793
7695	Screw Installed & Captivated	7794

Mounting Detail

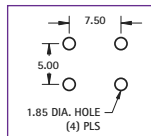

M3 THREAD CAT. NO.	No Screw Supplied	M4 THREAD CAT. NO.
7760	No Screw Supplied	7764
7761	Screw Supplied Unassembled	7765
7762	Screw Installed & Captivated	7766

VERTICAL TYPE



SNAP-IN PC MOUNT

- Color coded screws available (add color screw suffix to Cat. No.)

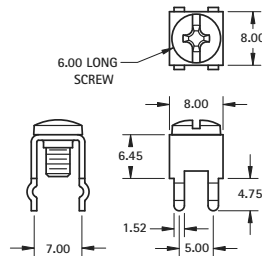

SPECIFICATIONS

Rated: 15 Amps
Terminal: .81 Brass, Matte Tin Plate
Screw: Brass, Nickel Plate

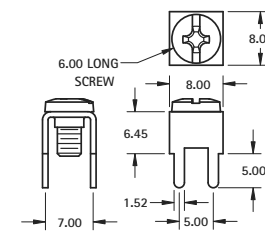

PC MOUNT

- Color coded screws available (add color screw suffix to Cat. No.)

M3 THREAD CAT. NO.	No Screw Supplied	M4 THREAD CAT. NO.
7788	No Screw Supplied	7795
7698	Screw Supplied Unassembled	7796
7696	Screw Installed & Captivated	7797

Mounting Detail

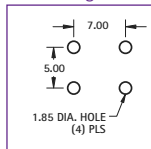

M3 THREAD CAT. NO.	No Screw Supplied	M4 THREAD CAT. NO.
7770	No Screw Supplied	7767
7771	Screw Supplied Unassembled	7768
7772	Screw Installed & Captivated	7769

30 AMP - VERTICAL TYPE



SNAP-IN PC MOUNT

- Color coded screws available (add color screw suffix to Cat. No.)

SPECIFICATIONS

Rated: 30 Amps
Terminal: .81 Brass, Matte Tin Plate
Screw: Brass, Nickel Plate

CAT. NO.	No Screw Supplied
7798	No Screw Supplied
7799	Screw Supplied Unassembled
7800	Screw Installed & Captivated

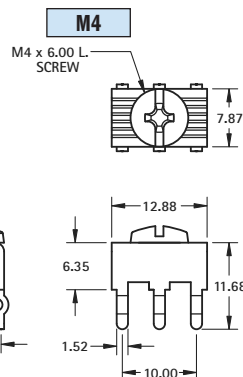

PRINCIPAL FEATURES

- Compact, heavy duty design
- Six snap-in legs for total stability
- Serrated top surface secures connection

Mounting Detail

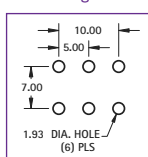

M5

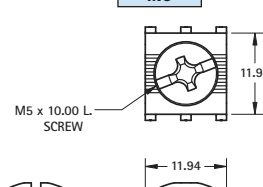

SNAP-IN PC MOUNT

SPECIFICATIONS

Rated: 30 Amps
Terminal: 1.14 Brass, Matte Tin Plate
Screw: Brass, Nickel Plate

CAT. NO.	No Screw Supplied
7807	No Screw Supplied
7808	Screw Supplied Unassembled

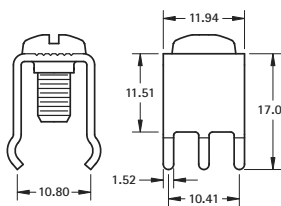

Mounting Detail

